







D7.0024.7750.58 , D7.0024.7757.51 , D7.0041.0573.54
 Výklopný systém FREEflap mini, typ B - šedá - bílá - antracit

i				
	mm 			
   	250	A	1,3 - 3,8	2716617035
		B	2,9 - 6,4	2716627035
		C	5,4 - 11,8	2716637035
	275	A	1,2 - 3,3	2716617035
		B	2,5 - 5,7	2716627035
		C	4,8 - 10,6	2716637035
	300	A	1,1 - 3,1	2716617035
		B	2,4 - 5,1	2716627035
		C	4,4 - 9,6	2716637035
	325	A	1,0 - 2,8	2716617035
		B	2,1 - 4,6	2716627035
		C	4,0 - 8,8	2716637035
350	A	0,9 - 2,6	2716617035	
	B	2,0 - 4,2	2716627035	
	C	3,7 - 8,1	2716637035	
375	A	0,9 - 2,3	2716617035	
	B	1,9 - 3,8	2716627035	
	C	3,5 - 7,5	2716637035	
400	A	0,8 - 2,1	2716617035	
	B	1,7 - 3,6	2716627035	
	C	3,2 - 7,0	2716637035	

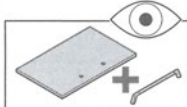

D7.0024.7750.58 , D7.0024.7757.51 , D7.0041.0573.54
 Výklopný systém FREEflap mini, typ B - šedá - bílá - antracit

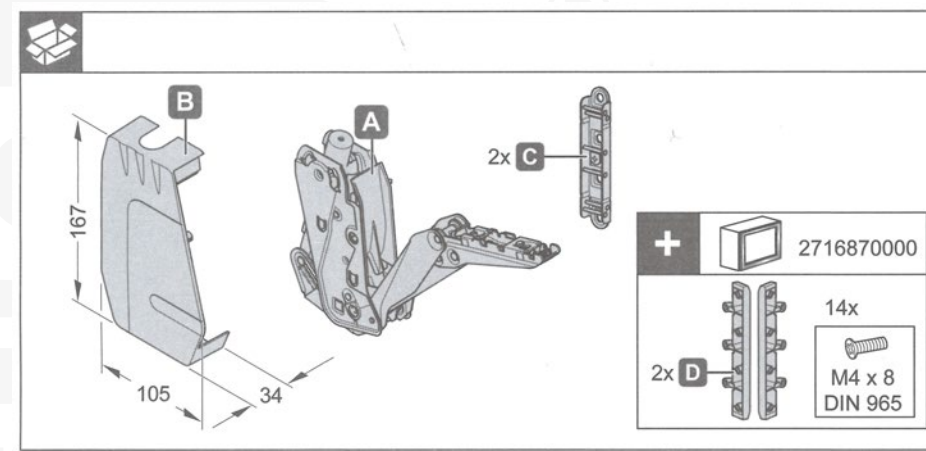