

Podložka H=0

K = 4
D = 9

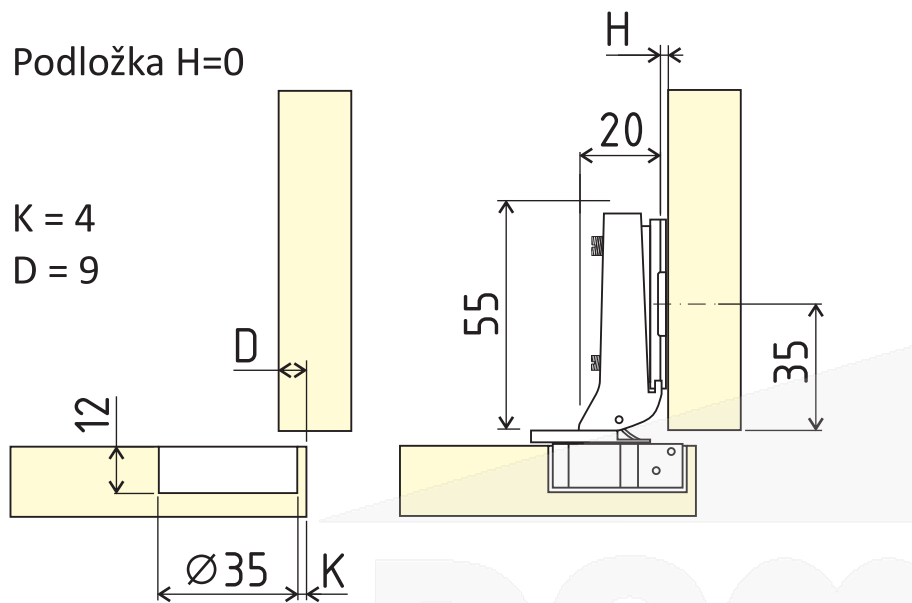

Uložení lze určit z vzorce $H = 5 + K - D$

Možnosti nastavení

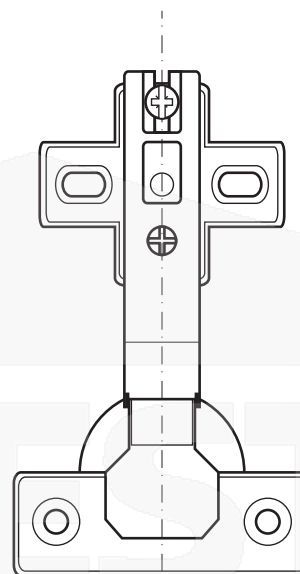
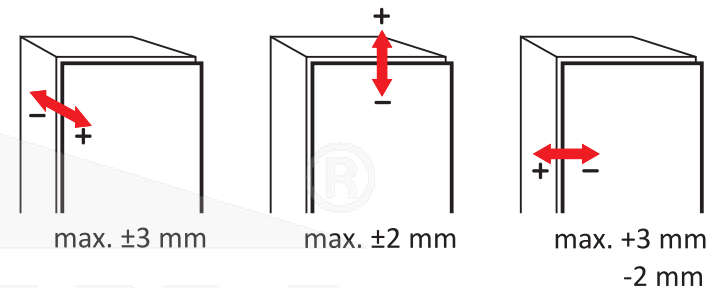

Mezní rozměry

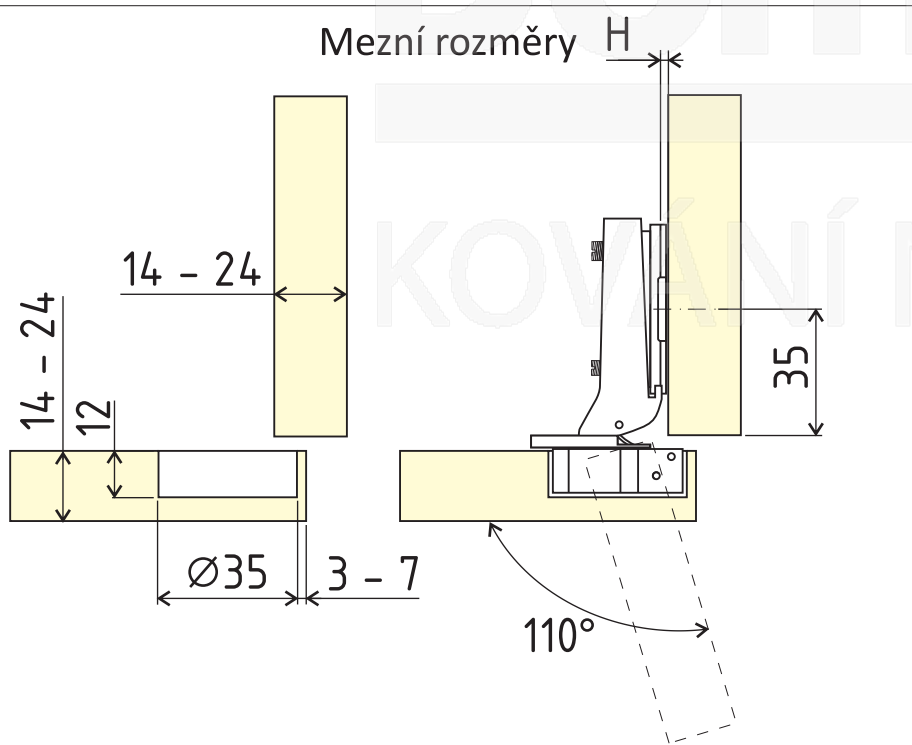

Doporučený počet závěsů

