



















# posuvný systém s úchytkovým profilem MODENA SLIM:

## doporučené komponenty:

- |   |   |   |   |
|---|---|---|---|
|    | ① Úchytkový profil MODENA SLIM<br>UL18, 2,7 m, hliník<br>DL.UL18.028.02   |    | ⑪ Stoper pro spodní vedení ELEGANT EXCLUSIVE<br>DL.UL18.015.00        |
|    | ② Tlumení s dotahem<br>UL18, sada 2 ks<br>DL.UL18.012.00                  |    | ⑫ Krycí lišta pro ELEGANT EXCLUSIVE<br>DL.UL18.209.02                 |
|    | ③ Horní vedení UNIVERSAL EXCLUSIVE<br>UL18, hliník, 2m<br>DL.UL18.208.02  |    | ⑬ Spodní vozík do profilu EXCLUSIVE<br>DL.UL18.016.00                 |
|    | ④ Stoper pro horní vedení<br>UL18<br>DL.UL18.013.00                       |    | ⑭ Dolní vedení ELEGANT EXCLUSIVE<br>DL.UL18.210.02                    |
|    | ⑤ Horní vozík do profilu EXCLUSIVE<br>UL18, pár<br>DL.UL18.011.00         |    | ⑮ H profil<br>DL.UL18.003.02  |
|   | ⑥ Horní rámový profil EXCLUSIVE<br>UL18, hliník, 1,5 m<br>DL.UL18.004.02  |   | ⑯ Horní vozík UNIVERSAL<br>UL18, montáž na LTD<br>DL.UL18.014.00      |
|  | ⑦ Dělicí rámový profil EXCLUSIVE<br>UL18, hliník, 1,5 m<br>DL.UL18.006.02 |  | ⑰ Spodní vozík ELEGANT<br>UL18, k zařezování do LTD<br>DL.UL18.017.00 |
|  | ⑧ Plast na vymezení skla<br>DL.UL18.020.00                                |   |   |
|  | ⑨ Dolní rámový profil EXCLUSIVE<br>UL18, hliník, 2 m<br>DL.UL18.005.02    |   |   |
|  | ⑩ Nasouvací kartáček<br>DL.UL18.027.00                                    |  | ⑱ Samolepící kartáček<br>DL.UL18.029.00                               |

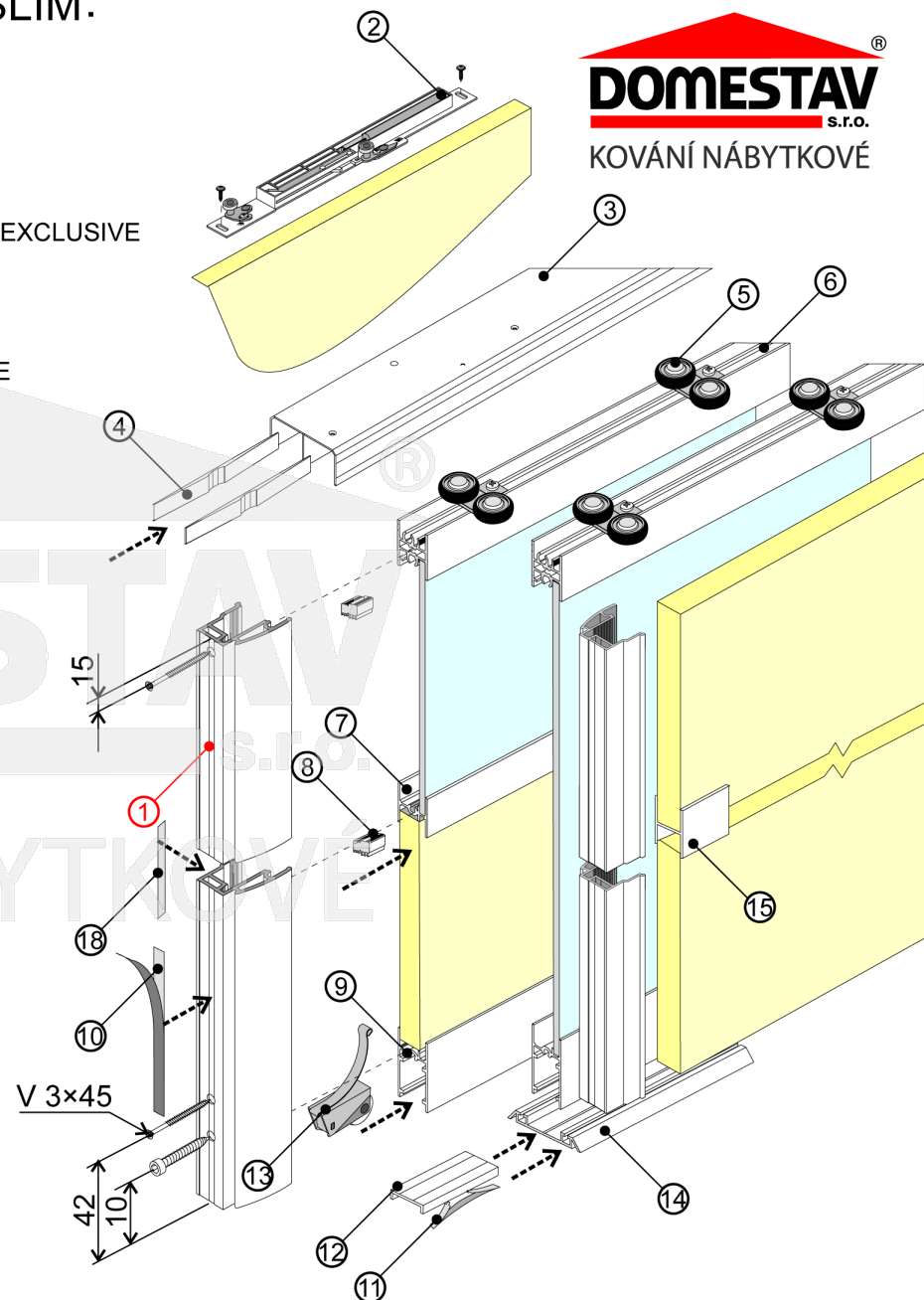

## montáž úchytkového profilu:

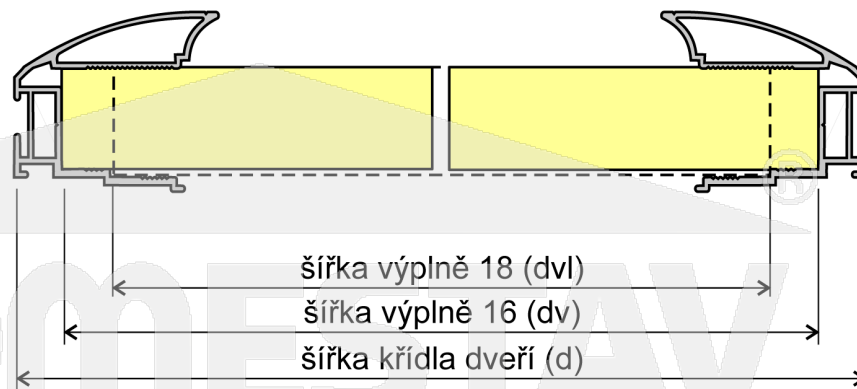
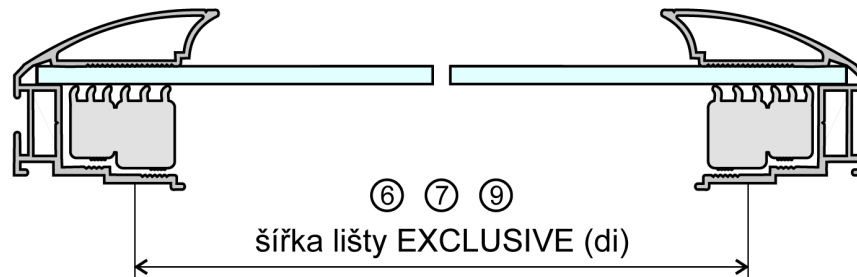
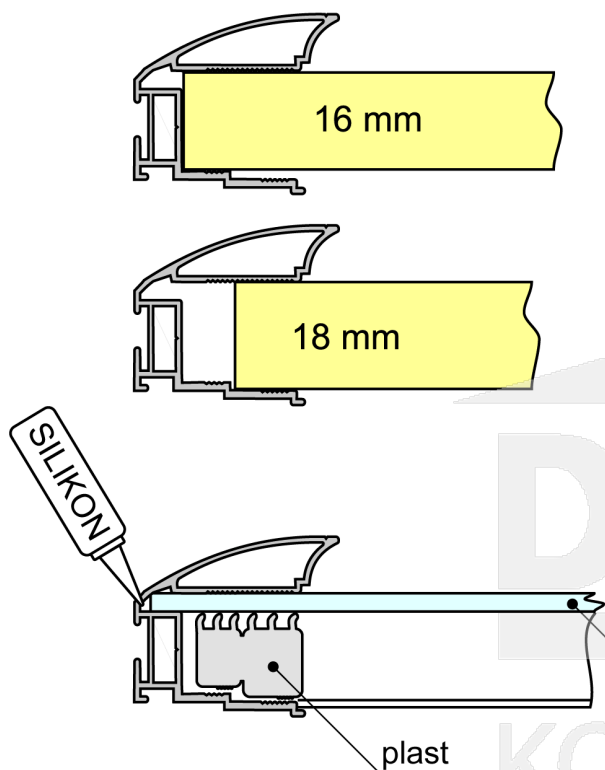

výplň dveří: DTD, MDF – tloušťka 18 nebo 16 mm  
: sklo, zrcadlo – tloušťka 4 mm  
hmotnost dveří max. 50 kg

## světlý otvor pro dveře:

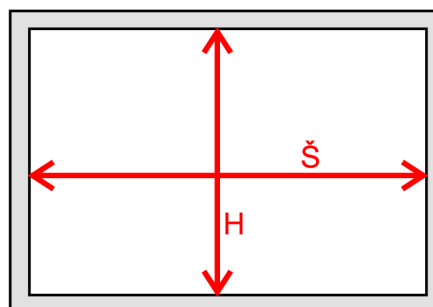

### výška dveří:

výška křídla dveří	h	$h = H - 37 \text{ mm}$
výška výplně LTD16,18	hv	$hv = h - 1,5 \text{ mm}$
výška výplně PROFIL LTD18	hvl	$hvl = h - 81 \text{ mm}$
výška výplně PROFIL sklo	hvs	$hvs = h - 69 \text{ mm}$

\* rozměry bez dělicího profilu ⑦ a ⑮

### šířka dveří:

šířka dveří	d	$d = (\text{Š} + p) / n$		
počet křídel	n	2	3	4
šířka přesahu	p	34	68	102
šířka výplně 16 mm	dv	$dv = d - 22$		
šířka skla	dvs	$dvs = d - 10$		
šířka výplně 18 mm	dvl	$dvl = d - 31$		
šířka profilu ⑥ ⑨ ⑦	di	$di = d - 50$		

# Dveřní výplně:

## Skleněná:

⑥ Horní profil:

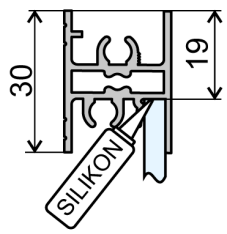

⑨ Dolní profil:

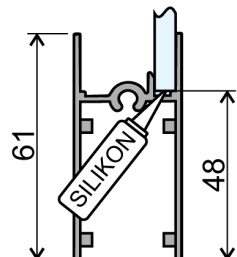

⑦ Dělicí profil:

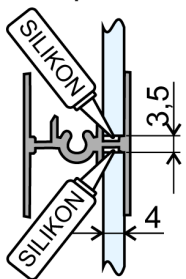

## LTD 18:

⑥ Horní profil:

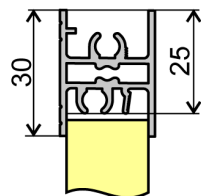

⑨ Dolní profil:

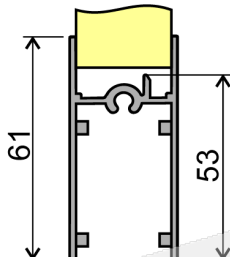

Dělicí profil:

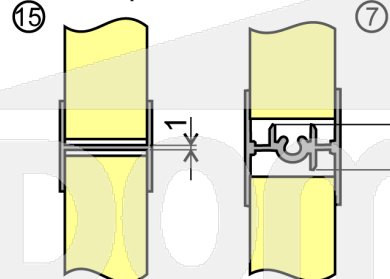

## Kombinovaná:

⑥ Horní profil:

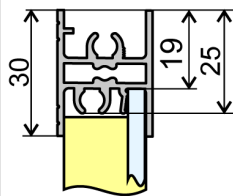

⑨ Dolní profil:

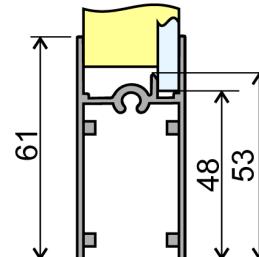

⑦ Dělicí profil:

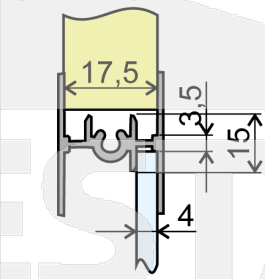



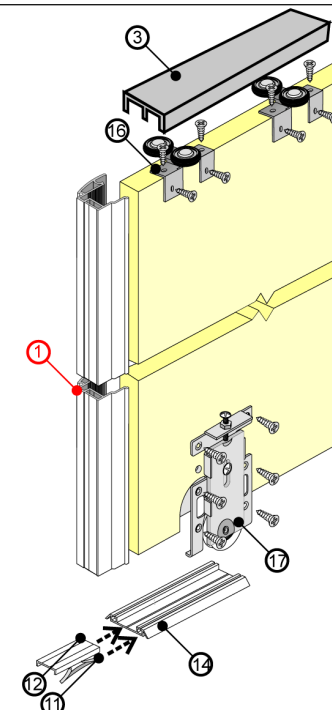
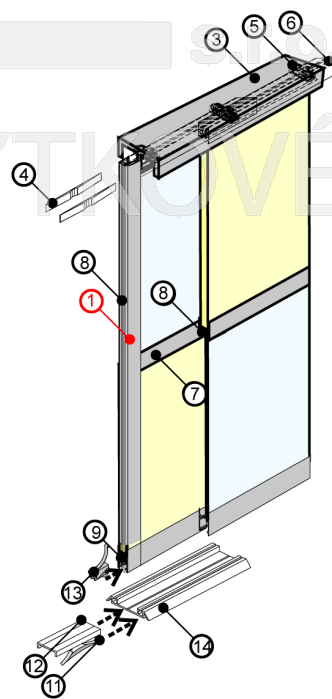
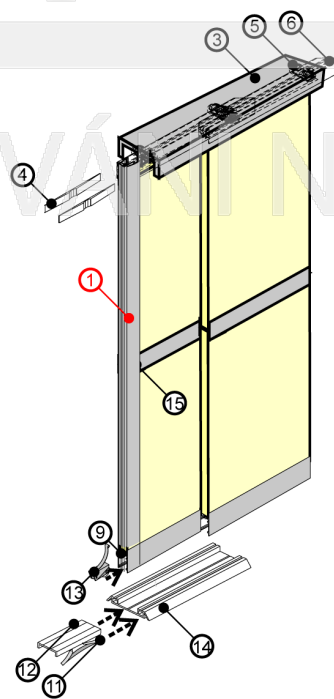
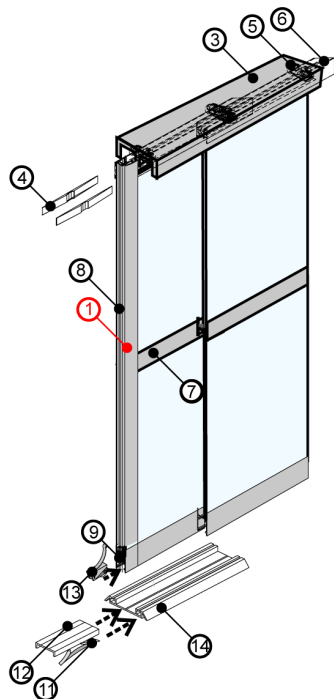
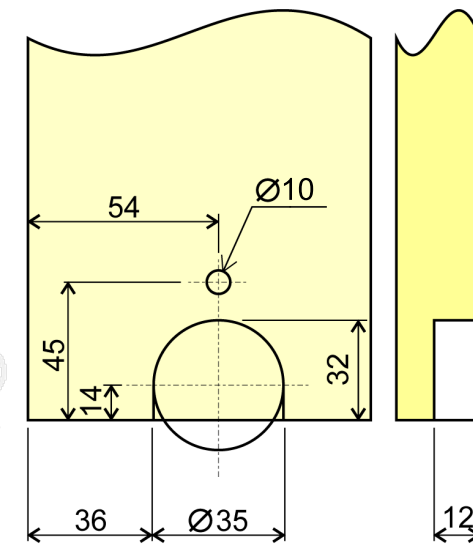















## Frézování LTD 16,18:



# posuvný systém s úchytkovým profilem TREND LINE:

## doporučené komponenty:

- |  |  |
|--|--|
|  ① Úchytkový profil TREND LINE<br>UL18, 2,7 m, hliník<br>DL.UL18.002.02      |  ⑪ Stoper pro spodní vedení ELEGANT EXCLUSIVE<br>DL.UL18.015.00           |
|  ② Tlumení s dotahem<br>UL18, sada 2 ks<br>DL.UL18.012.00                    |  ⑫ Krycí lišta pro ELEGANT EXCLUSIVE<br>DL.UL18.209.02                    |
|  ③ Horní vedení UNIVERSAL EXCLUSIVE<br>UL18, hliník, 2m<br>DL.UL18.208.02    |  ⑬ Spodní vozík do profilu EXCLUSIVE<br>DL.UL18.016.00                    |
|  ④ Stoper pro horní vedení<br>UL18<br>DL.UL18.013.00                         |  ⑭ Dolní vedení ELEGANT EXCLUSIVE<br>DL.UL18.210.02                       |
|  ⑤ Horní vozík do profilu EXCLUSIVE<br>UL18, pár<br>DL.UL18.011.00           |  ⑮ H profil<br>DL.UL18.003.02   |
|  ⑥ Horní rámový profil EXCLUSIVE<br>UL18, hliník, 1,5 m<br>DL.UL18.004.02   |  ⑯ Horní vozík UNIVERSAL<br>UL18, montáž na LTD<br>DL.UL18.014.00        |
|  ⑦ Dělicí rámový profil EXCLUSIVE<br>UL18, hliník, 1,5 m<br>DL.UL18.006.02 |  ⑰ Spodní vozík ELEGANT<br>UL18, k zafrézování do LTD<br>DL.UL18.017.00 |
|  ⑧ Plast na vymezení skla<br>DL.UL18.020.00                                |  |
|  ⑨ Dolní rámový profil EXCLUSIVE<br>UL18, hliník, 2 m<br>DL.UL18.005.02    |  |
|  ⑩ Nasouvací kartáček<br>DL.UL18.024.00                                    |  ⑱ Samolepící kartáček<br>DL.UL18.029.00                                |

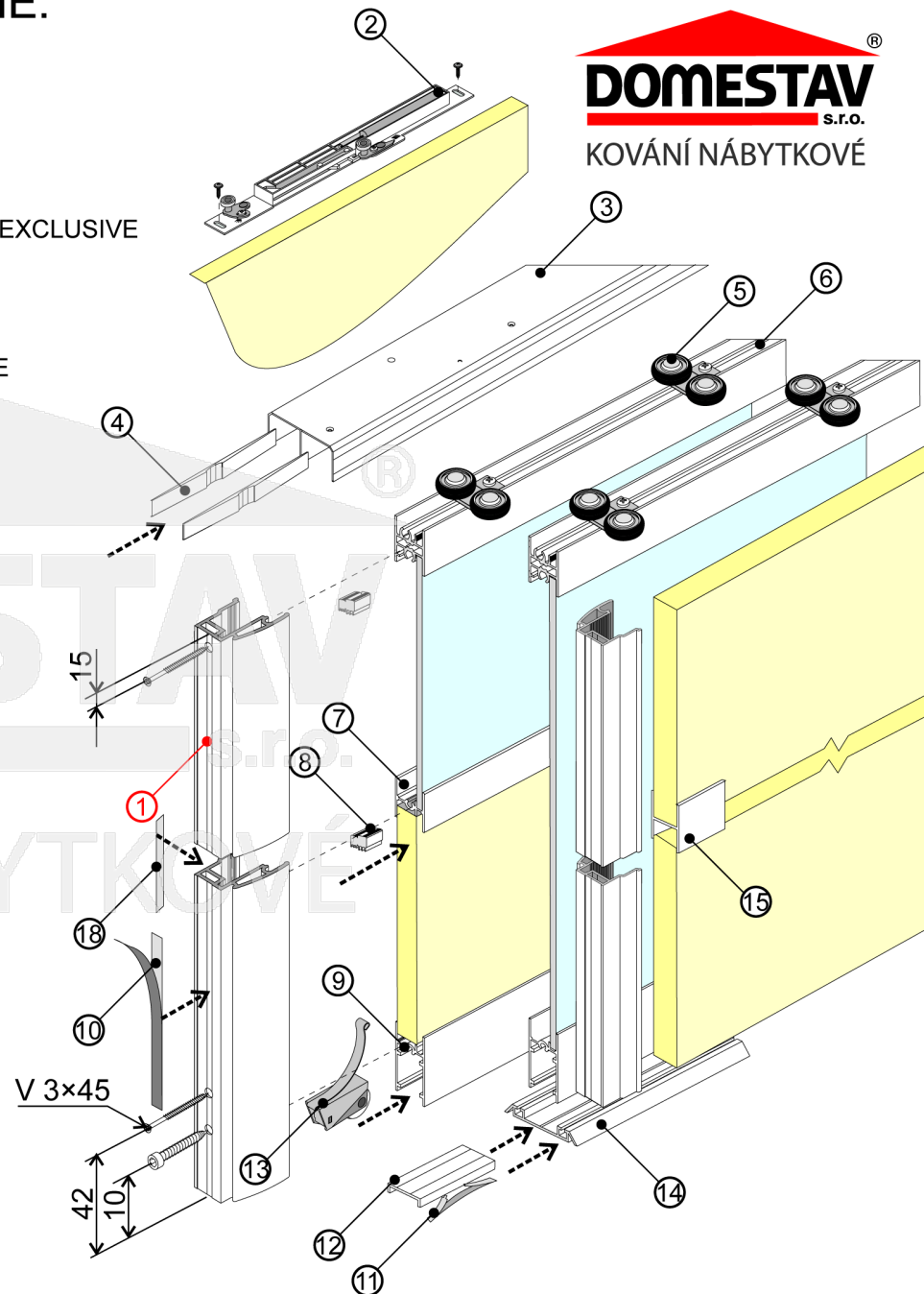

## montáž úchytkového profilu:

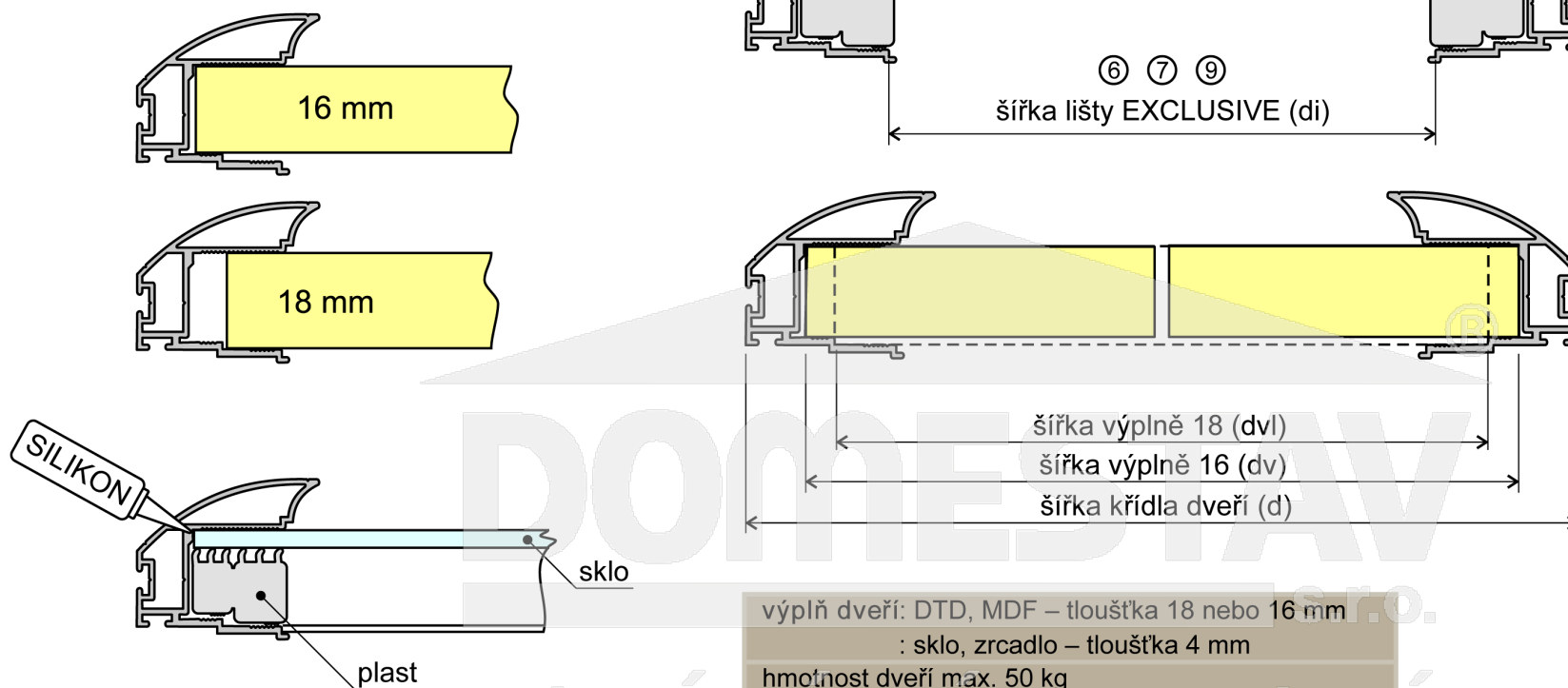

### výška dveří:

výška křídla dveří	h	$h = H - 37 \text{ mm}$
výška výplně LTD16,18	hv	$hv = h - 1,5 \text{ mm}$
výška výplně PROFIL LTD18	hvl	$hvl = h - 81 \text{ mm}$
výška výplně PROFIL sklo	hvs	$hvs = h - 69 \text{ mm}$

\* rozměry bez dělicího profilu ⑦ a ⑮

### světlý otvor pro dveře:

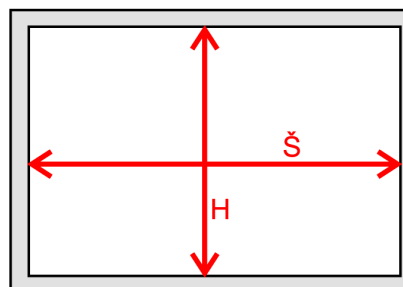

### šířka dveří:

šířka dveří	d	$d = (\text{Š} + p) / n$		
počet křídel	n	2	3	4
šířka přesahu	p	34	68	102
šířka výplně 16 mm	dv	$dv = d - 20$		
šířka skla	dvs	$dvs = dv - 20$		
šířka výplně 18 mm	dvl	$dvl = d - 30$		
šířka profilu ⑥ ⑨ ⑦	di	$di = d - 52$		

# Dveřní výplně:

## Skleněná:

⑥ Horní profil:

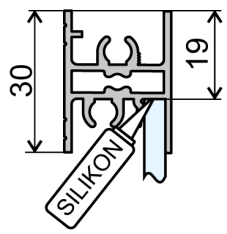

⑨ Dolní profil:

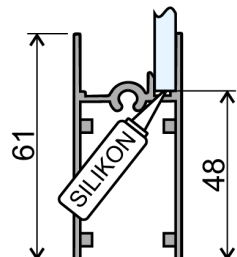

⑦ Dělicí profil:

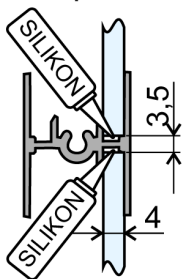

## LTD 18:

⑥ Horní profil:

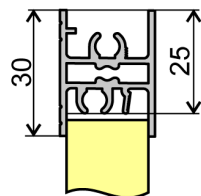

⑨ Dolní profil:

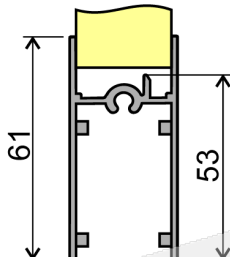

Dělicí profil:

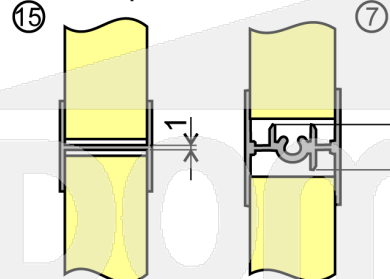

## Kombinovaná:

⑥ Horní profil:

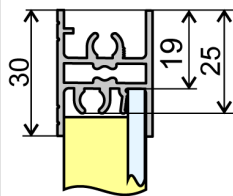

⑨ Dolní profil:

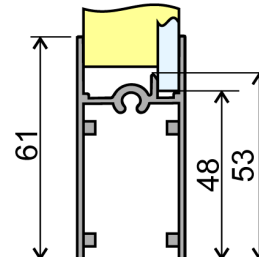

⑦ Dělicí profil:

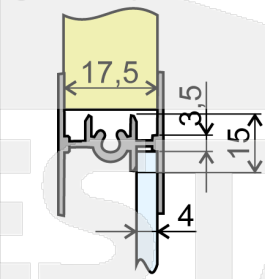

## Frézování LTD 16,18:

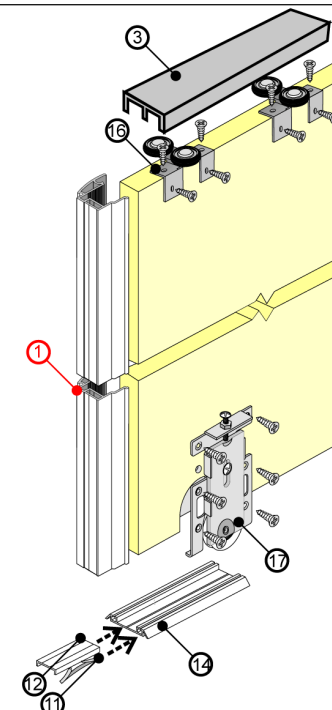
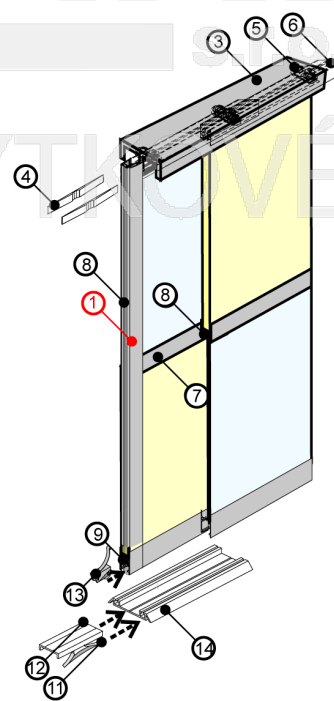
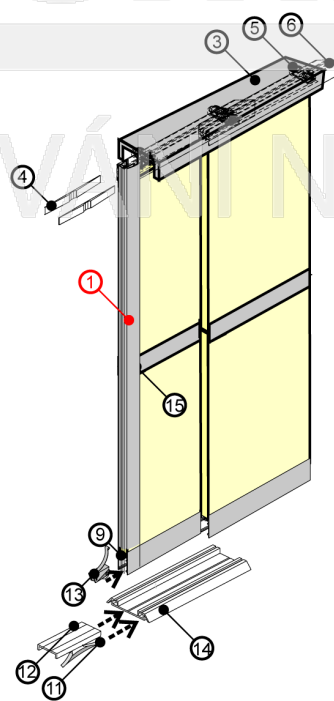
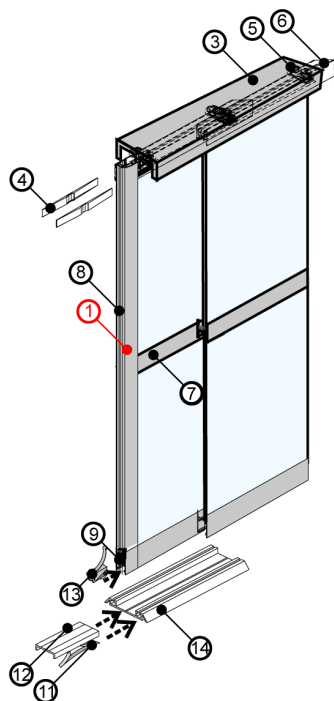
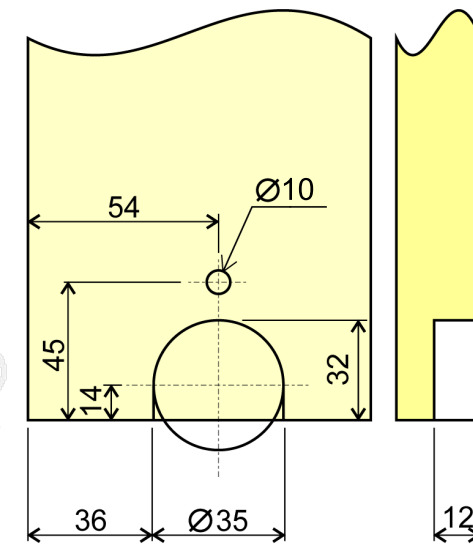

# posuvný systém s úchytkovým profilem BETA:

## základní komponenty pro skříň se dvěma dveřmi:



- ① Úchytkový profil BETA (2 ks)  
UL18, 2,7 m, hliník  
DL.UL18.001.02



- ⑪ C profil (2 ks)  
UL18, hliník, 1,5 m  
DL.UL18.007.02



- ② Tlumení s dotahem (2 ks)  
UL18, sada 2 ks  
DL.UL18.012.00



- ⑫ Samolepící protiprachový kartáček (2 ks)  
UL18, 13 mm  
DL.UL18.029.00



- ③ Horní vedení UNIVERSAL EXCLUSIVE (1 ks)  
UL 18, hliník, 2m  
DL.UL18.208.02



- ④ Stoper pro horní vedení (4 ks)  
UL18  
DL.UL18.013.00



- ⑤ Horní vozík UNIVERSAL (4 ks)  
UL18, montáž na LTD  
DL.UL18.014.00



- ⑥ Samolepící dorazový kartáček (4 ks)  
UL18, 4,8 x 4 mm  
DL.UL18.023.00

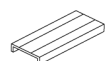

- ⑦ Krycí lišta pro ELEGANT EXCLUSIVE (1 ks)  
UL 18, hliník, 2 m  
DL.UL18.209.02



- ⑧ Spodní vozík ELEGANT (4 ks)  
UL 18, k zafrézování do LTD  
DL.UL18.017.00



- ⑨ Stoper pro spodní vedení ELEGANT EXCLUSIVE (4 ks)  
UL 18  
DL.UL18.015.00



- ⑩ Dolní vedení ELEGANT EXCLUSIVE (1 ks)  
UL 18, hliník, 2 m  
DL.UL18.210.02

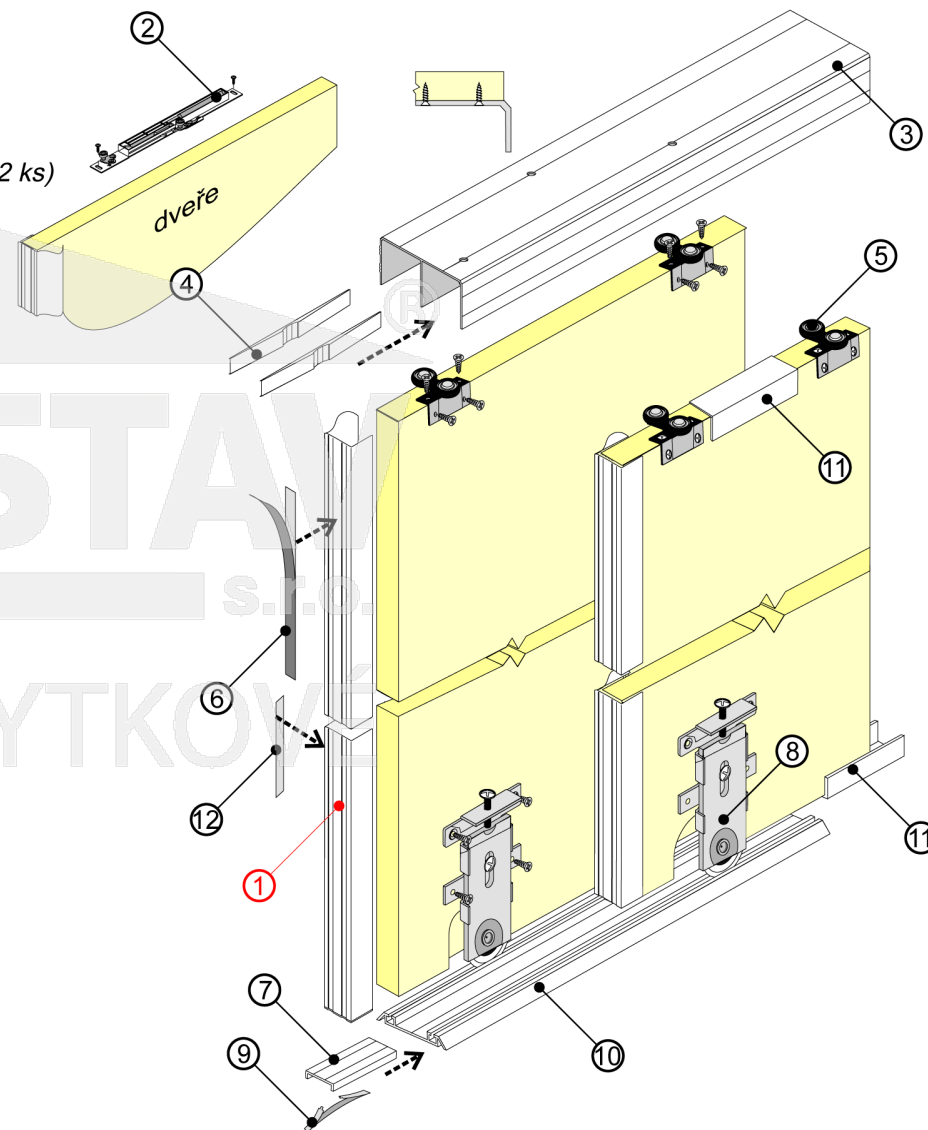

pohled z boku:

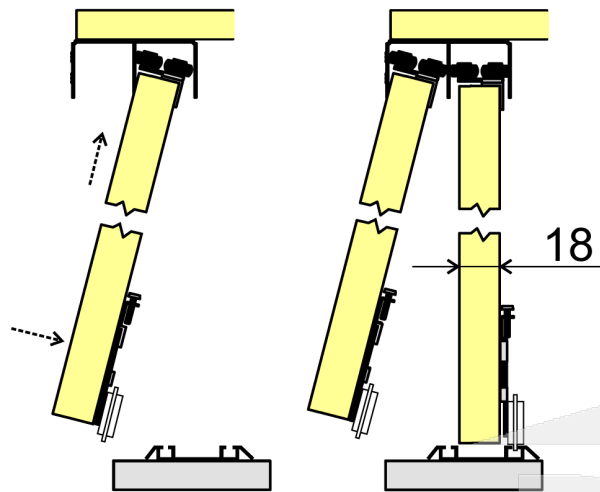

montáž úchytkového profilu:

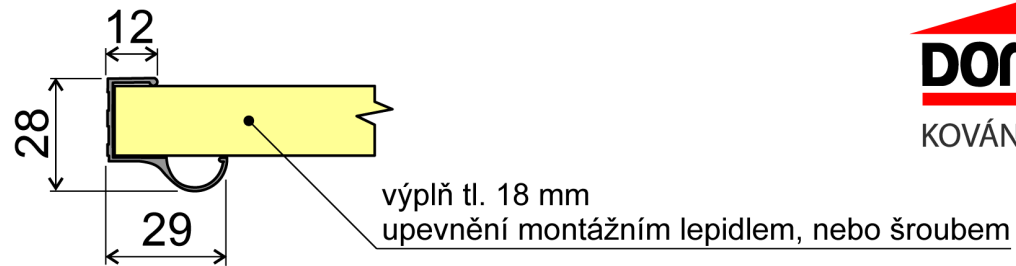

uchycení spodního vozíku:

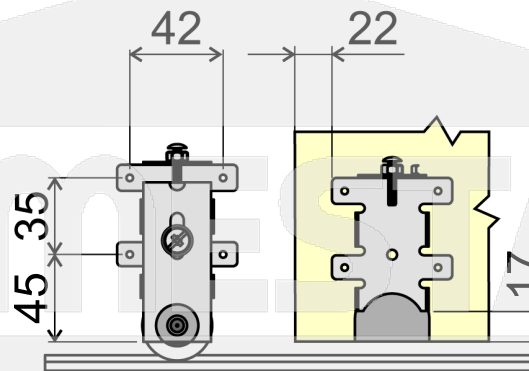

světlý otvor pro dveře:

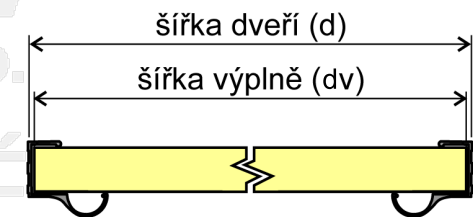
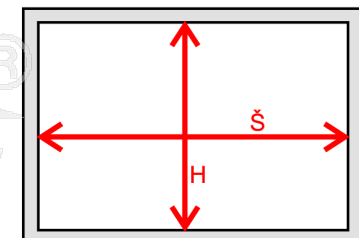

frézování:

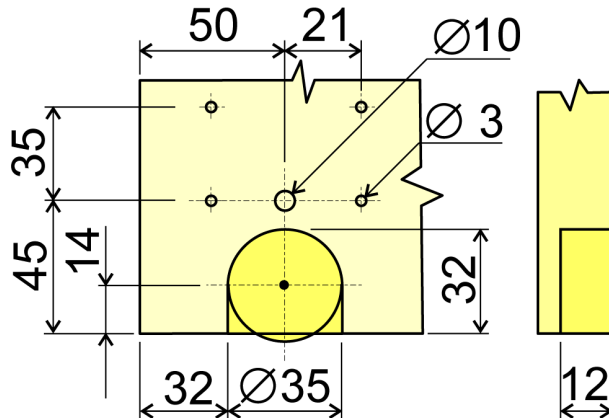

uchycení horního vozíku:

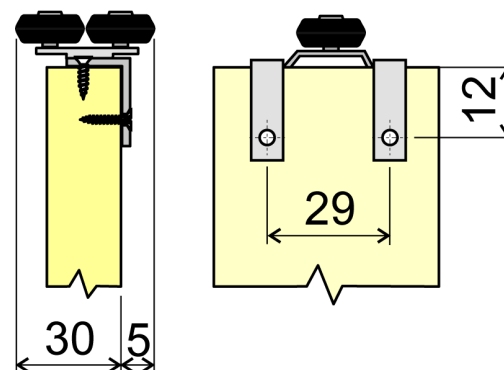

výplň dveří: DTD, MDF, tloušťky 18  
hmotnost dveří max. 50 kg

šířka dveří	d	$d = (\text{Š} + p) / n$
šířka výplně	dv	$dv = d - 4$
výška křídla dveří	h	$h = H - 37 \text{ mm}$
výška výplně	hv	$hv = h - 1,5$

počet křídel	n	2	3	4
šířka přesahu	p	30	60	90



## Doplňky:



- ⑪ C profil (2 ks)  
UL18, hliník, 1,5 m  
DL.UL18.007.02



- ⑥ Samolepící dorazový kartáček (4 ks)  
UL18, 4,8 x 4 mm  
DL.UL18.023.00



- ⑫ Samolepící protiprachový kartáček (2 ks)  
UL18, 13 mm  
DL.UL18.029.00



- ② Tlumení s dotahem (2 ks)  
UL18, sada 2 ks  
DL.UL18.012.00

