

Podložka H=1

A = 1
K = 3
S = 16

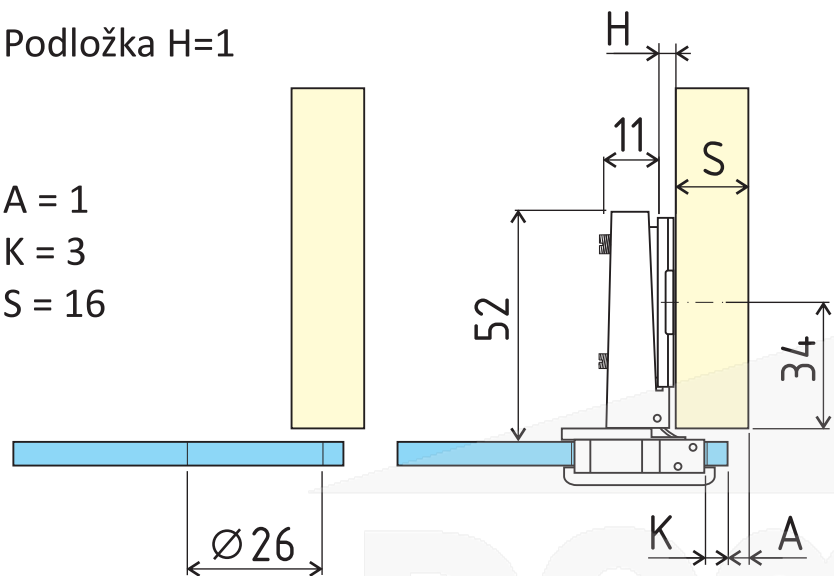

Uložení lze určit z vzorce $H = (13+A+K)-S$

Mezní rozměry

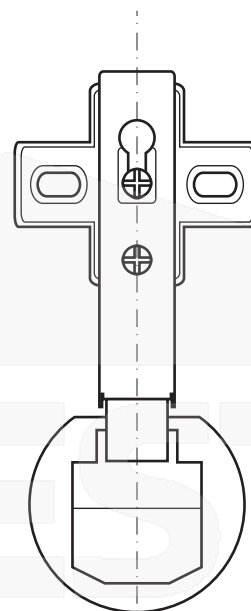
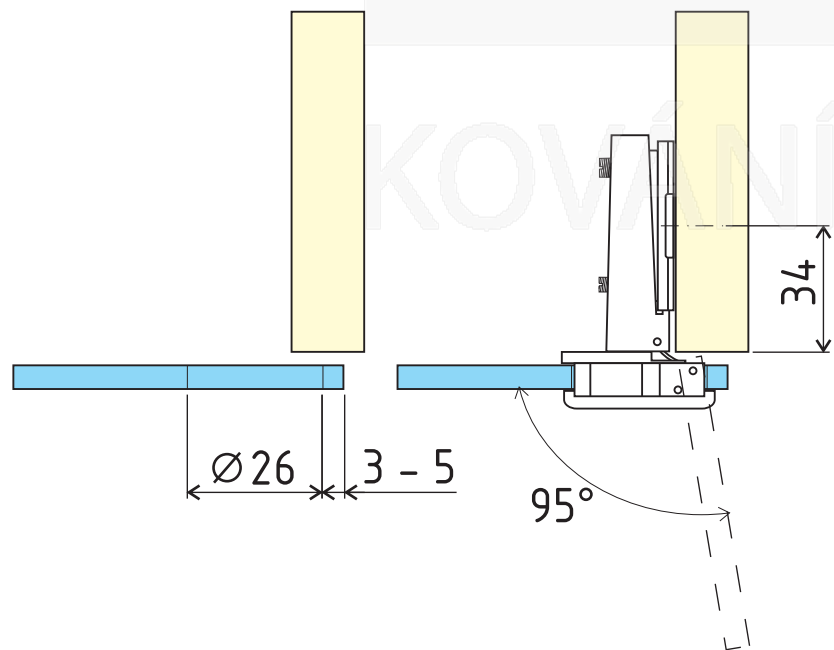

Možnosti nastavení

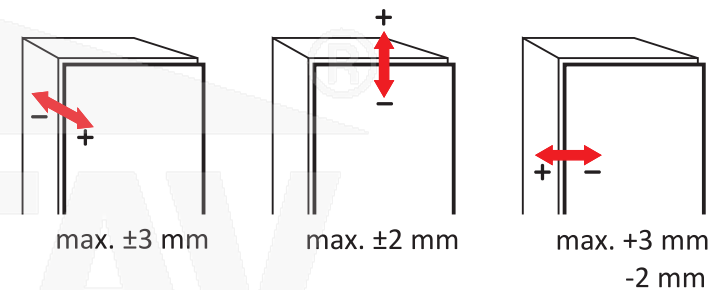

Doporučený počet závěsů

